

# Operation Manual for Torque Sensor

For below and similar Types

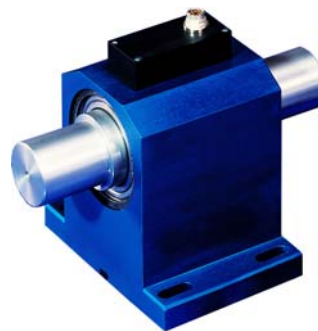

86-2112  
86-2112-R  
86-2412  
86-2412-R



86-2212  
86-2212-R  
86-2512  
86-2512-R

## References in this Text

### 1.6 Warning Notes; Page 5



Attention must be paid to the accident prevention regulations of the trade associations. Coverings and casings are necessary before operating the sensor. This is also valid for commissioning, maintenance and trouble shooting.

Duties of the coverings and casings are:

- ⇒ Protection from detaching parts
- ⇒ Protection from contusion and shear
- ⇒ Prevention from reaching rotating parts
- ⇒ Prevention from being tangled up and/or getting caught by parts

Coverings may

- ⇒ Not grind
- ⇒ Not rotate

Coverings are also necessary outside of operating and motion travel areas of persons. These demands can be modified if other sufficient safety devices are available. During operation, the safety precautions must be operative. By vibrations, damages can occur at the device.

### 4 Mechanical Assembly; Page 7



During the assembly, the sensor must be supported to protect it from falling down.

#### 4.1.3 Alignment of the Measurement Arrangement; Page 7



For further references see coupling manual.

#### 4.2 General; Page 7



Before the assembly, shafts must be cleaned with dissolver (e.g. acetone), no foreign particles may adhere to them. The hub must fit corresponding to the connection.



**Caution:** During the assembly inadmissibly large forces may not act on the sensor or the couplings. At small torques (< 20 N·m) connect the sensor electrically during the assembly and observe the signal, the measurement signal may not exceed the limit values

#### 4.2.1 Torque Sensors of 0,03 Nm to 15 Nm; Page 8



Sensors with nominal torques below 20 N·m are very sensitive to overload, therefore these sensors need to be handled with greatest caution.

#### 4.3 Freefloating Assembly; Page 8+9



**Caution:** During the assembly inadmissibly large forces may not act on the sensor or the couplings.



In this installation case, double-jointed couplings can not be used for both sides!  
**Risk of Breakage!**

#### 4.4 Foot Version Assembly; Page 9



**Caution:** During the assembly inadmissibly large forces may not act on the sensor or the couplings.

#### 6.1 Engaging; Page 11



Warming-up period of the torque sensor is approx. 5 min.

#### 6.4.2 Natural Resonances; Page 12



An operation of the device in natural resonance can lead to permanent damages.

## Contents

1	Read First .....	4
1.1	Safety and Caution Symbols .....	4
1.2	Intended Use .....	4
1.3	Dangers .....	4
1.3.1	Neglecting of Safety Notes .....	4
1.3.2	Remaining Dangers .....	4
1.4	Reconstructions and Modifications .....	4
1.5	Personnel .....	4
1.6	Warning Notes .....	4
2	Term Definitions .....	5
2.1	Terms .....	5
2.2	Definition of the Pictograms on the Torque Sensor .....	5
3	Product Description .....	5
3.1	Mechanical Setup .....	5
3.2	Electrical Setup .....	6
3.2.1	Sensors with Analog Output .....	6
3.2.2	Sensors with RS485 Interface .....	6
4	Mechanical Assembly .....	7
4.1	Couplings .....	7
4.1.1	Misalignment Possibilities of Single-Jointed Couplings .....	7
4.1.2	Double-Jointed Couplings .....	7
4.1.3	Alignment of the Measurement Arrangement .....	7
4.2	General .....	7
4.2.1	Torque Sensors of 0,03 N·m to 15 N·m .....	8
4.2.2	Torque Sensors from 20 N·m .....	8
4.3	Freefloating Assembly .....	8
4.4	Foot Version Assembly .....	9
5	Electrical Connection .....	10
5.1	Pin Connection .....	10
5.2	Calibration Control .....	10
5.2.1	Calibration Control at Analog Output .....	10
5.2.2	Calibration Control at RS485 .....	11
5.3	Cable .....	11
5.4	Shielding Connection .....	11
5.5	Running of Measuring Cables .....	11
5.6	Angle (Option) .....	11
6	Measuring .....	11
6.1	Engaging .....	11
6.2	Direction of Torque .....	11
6.3	Static / Quasi-Static Torques .....	11
6.4	Dynamic Torques .....	12
6.4.1	General .....	12
6.4.2	Natural Resonances .....	12
6.5	Speed Limits .....	12
6.6	Disturbance Variables .....	12
7	Maintenance .....	12
7.1	Maintenance Schedule .....	12
7.2	Trouble Shooting .....	13
8	Decommission .....	13
9	Transportation and Storage .....	13
9.1	Transportation .....	13
9.2	Storage .....	14
10	Disposal .....	14
11	Calibration .....	14
11.1	Proprietary Calibration .....	14
11.2	DKD-Calibration .....	14
11.3	Re-Calibration .....	14
12	Data Sheet .....	14

## 1 Read First

### 1.1 Safety and Caution Symbols



**Caution:**

Injury Risk for Persons  
Damage of the Device is possible.

**Note:**

Important points to be considered.

### 1.2 Intended Use

Torque sensors are intended for the measurement of torques. This measurand is further suitable for control tasks. The valid safety regulations should be absolutely respected. The torque sensors are not safety components in the sense of the intended use. The sensors need to be transported and stored appropriately. The assembly, commissioning and disassembling must take place professionally.

### 1.3 Dangers

The torque sensor is fail-safe and corresponds to the state of technology.

#### 1.3.1 Neglecting of Safety Notes

At inappropriate use, remaining dangers can emerge (e.g. by untrained personnel). The operation manual must be read and understood by each person entrusted with the assembly, maintenance, repair, operation and disassembly of the torque sensor.

#### 1.3.2 Remaining Dangers

The plant designer, the supplier, as well as the operator must plan, realize and take responsibility for safety-related interests for the sensor. Remaining dangers must be minimized. Remaining dangers of the torque measurement technique must be pointed out. Human mistakes must be considered. The construction of the plant must be suitable for the avoidance of dangers. A danger-analysis for the plant must be carried out.

### 1.4 Reconstructions and Modifications

Each modification of the sensors without our written approval excludes liability on our part.

### 1.5 Personnel

The installation, assembly, commissioning, operation and the disassembly must be carried out by qualified personnel only. The personnel must have the knowledge and make use of the legal regulations and safety instructions.

### 1.6 Warning Notes



Attention must be paid to the accident prevention regulations of the trade associations.

Coverings and casings are necessary before operating the sensor. This is also valid for commissioning, maintenance and trouble shooting.

Duties of the coverings and casings are:

- ⇒ Protection from detaching parts
- ⇒ Protection from contusion and shear
- ⇒ Prevention from reaching rotating parts
- ⇒ Prevention from being tangled up and/or getting caught by parts

Coverings may

- ⇒ Not grind
- ⇒ Not rotate

Coverings are also necessary outside of operating and motion travel areas of persons.

These demands can be modified if other sufficient safety devices are available. During operation, the safety precautions must be operative. By vibrations, damages can occur at the device.

## 2 Term Definitions

### 2.1 Terms

#### Measuring Side:

Mechanical connection of the torque sensor in which the torque to be measured is applied. Usually this side has the smallest moment of inertia.

#### Drive Side:

Mechanical connection of the torque sensor on the opposite side of the measuring side, usually with the largest moment of inertia. At static torque sensors the housing is fastened on this side.

#### Low Torque Resistance Side:

The shaft of the arrangement (drive, load) which can be turned considerably smaller with torque than the nominal torque of the torque sensor  $M \ll M_{nenn}$ .

### 2.2 Definition of the Pictograms on the Torque Sensor

The measuring side of the torque sensor is designated as follows:

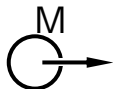
Measuring side:  or M

More information can be found on the data sheet, if needed.

## 3 Product Description

The sensor measures static and dynamic torques. The mounting position of the torque sensor is horizontally.

Caution: it is to be differentiated between measuring side and drive side, see data sheet of the sensor: <http://www.burster.it>

### 3.1 Mechanical Setup

The sensors consist of a torsion shaft. Depending on design, the mechanical connection possibilities are executable with round shafts or feather key connections etc. The torsion shaft, applied with two strain gauge full bridges, is bedded in a housing through ball bearings. For the signal transmission and/or the supply of the strain gauge full bridges, a rotating transformer, according to the principle of a transformer, is arranged in the sensor. For supply and measuring signal conditioning, electronics are integrated in the stator and the rotor.

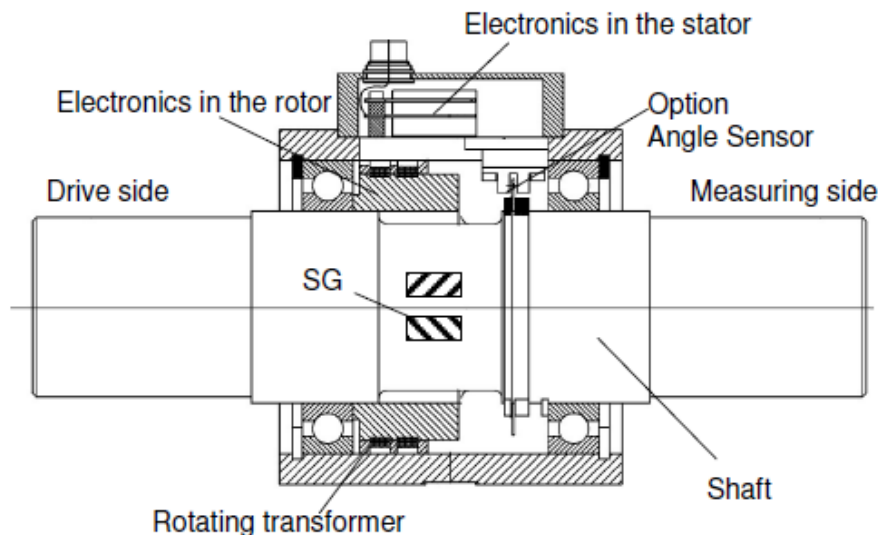

### 3.2 Electrical Setup

The supply of the rotor electronics occurs by an alternating voltage, generated in the stator, which transfers to the rotor through a rotating transformer. There, it is rectified and stabilized. With this supply, the strain gauge bridge is fed.

For the electrical calibration control of the sensor, a control signal is up-modulated to the supply by the  $\mu$ -processor in the stator and transferred to the rotor. There, it is filtered and evaluated by the  $\mu$ PC, which also activates the internal switch for the detuning of the strain gauge bridge.

The measuring signal of the strain gauge bridge is conditioned in an amplifier and then converted into a digital signal, which will be transferred to the stator by another rotating transformer. Compared to the analog signal, the measuring signal in digital form is much more disturbance-free. The remaining distance of the measuring signal within the sensor occurs in digital form, completely. Thus, the measuring system achieves a high reliability of operation.

This signal is further conditioned in the stator, comes into a  $\mu$ -processor, then - depending upon sensor type - it is converted to a voltage signal, digital signal or to current and will then reach the output of the sensor and can be directly measured at the connector.

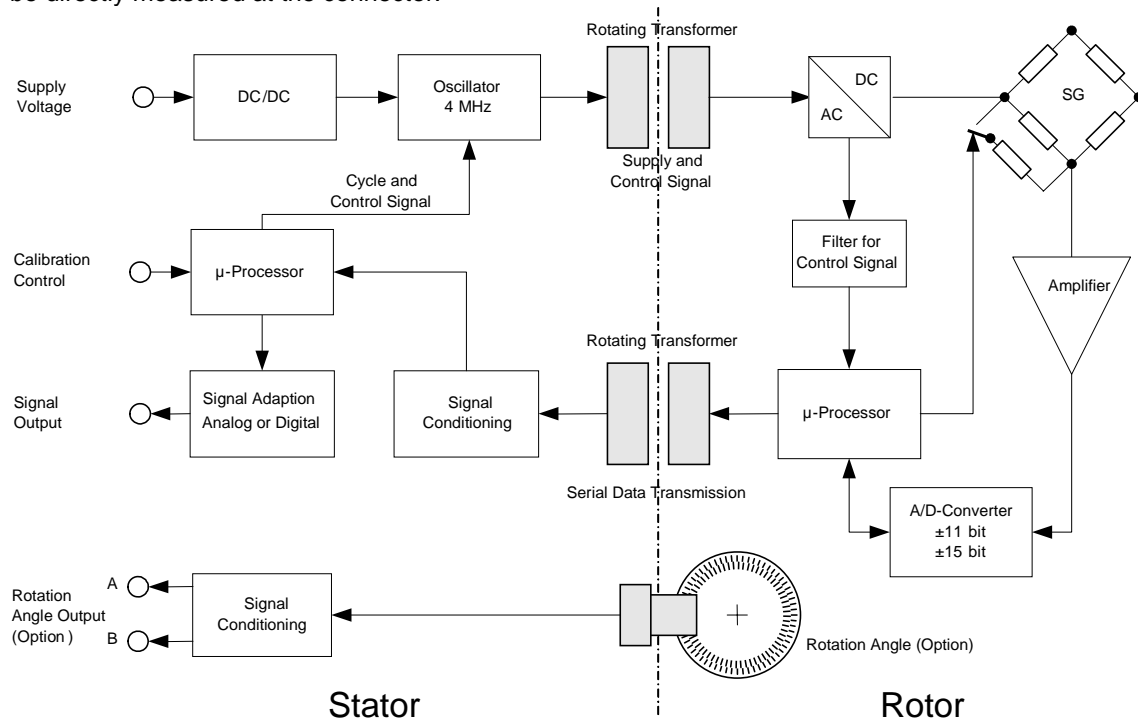

Block diagram for serial signal transmission

### 3.3 Sensors with Analog Output

At this output, the digital signal is converted into DC voltage of  $0\text{ V} \pm 5\text{ V}$ , proportionally to the torque and is available at the connector output.

### 3.4 Sensors with RS485 Interface

The torque sensor has a digital interface RS485 for the signal output and automatic sensor identification. The protocol enables high dynamics. See separate manual for further information.

## 4 Mechanical Assembly

For the assembly of a torque sensor in a shaft line, we always recommend to use couplings which can be misaligned.



During the assembly, the sensor must be supported to protect it from falling down.

### 4.1 Couplings

We recommend multi-disc couplings for our torque sensors. Couplings must be able to balance an axial, radial or angular offset of the shafts and not allow large forces to act on the sensor. The assembly instructions of the respective coupling manufacturer must be considered.

#### 4.1.1 Misalignment Possibilities of Single-Jointed Couplings

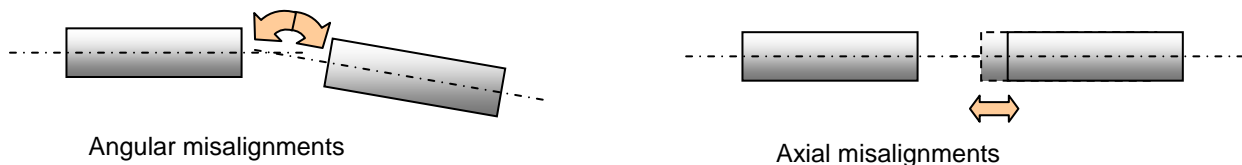

**Note:** Radial misalignments are only possible in the combination of single-jointed coupling - torque sensor (as adapter) - single-jointed coupling. Thus, with both single-jointed couplings the torque sensor forms a double-jointed coupling.

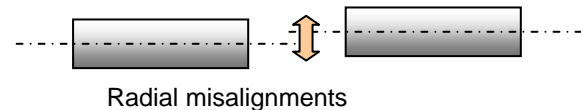

#### 4.1.2 Double-Jointed Couplings

Double-jointed couplings are used for the balance of inevitable angular, axial and radial misalignments.

#### 4.1.3 Alignment of the Measurement Arrangement

Precisely alignment of the couplings reduces the reaction forces and increases the durability of the couplings. Disturbance variables are minimized as well.

Due to the multitude of applications, an alignment of the coupling with a straight edge in two levels, vertical to each other, is sufficient.

However, in drives with high speed an alignment of the coupling (shaft ends) with a dial gauge or a laser is recommended.



For further references see coupling manual.

### 4.2 General



Before the assembly, shafts must be cleaned with dissolver (e.g. acetone), no foreign particles may adhere to them. The hub must fit corresponding to the connection.

#### Connections with Clamping Piece:

The indications of the clamping piece manufacturer must be considered. The clamping piece must be able to transfer the arising torques safely.



**Caution:** During the assembly inadmissibly large forces may not act on the sensor or the couplings. At small torques (< 20 Nm) connect the sensor electrically during the assembly and observe the signal, the measurement signal may not exceed the limit values

#### 4.2.1 Torque Sensors of 0,03 Nm to 15 Nm



Sensors with nominal torques below 20 Nm are very sensitive to overload, therefore these sensors need to be handled with greatest caution.

1. Connect the sensor electrically during the assembly and observe the measuring signal; the limit values may not be exceeded in any case.
2. Align the arrangement before the parts are connected firmly.
3. Assemble the sensor at the **low torque resistance side** first, then at the stationary side (this avoids impermissibly large torques from acting on the sensor).
4. Counter-hold by hand, so that impermissibly large torques or disturbance variables can not act on the torque sensor

#### 4.2.2 Torque Sensors from 20 Nm

The hub must fit corresponding to the connection.

#### 4.3 Freefloating Assembly

The sensor is installed between two single-jointed couplings and contributes to the balance of an inevitable axis offset between the two mechanical connections.

If no couplings are used, very large transverse forces can affect the sensor. In addition, large forces occur on the bearings in drive and output, which limit their life span very strongly.

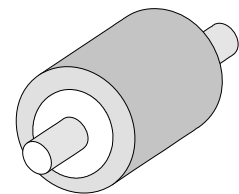

Shift couplings on shafts (use entire clamping length of the coupling) and align shafts.

Assure absolutely that the data of the couplings (axis offset, angular offset, tension, compression) are not exceeded.



**Caution:** During the assembly inadmissibly large forces may not act on the sensor or the couplings.

The housing must be protected from twisting e.g. by a flexible connection. The cable connection may not be used for this.

The cable connection must be placed loosely (form of goose neck), so that it can follow the light movements of the stator.

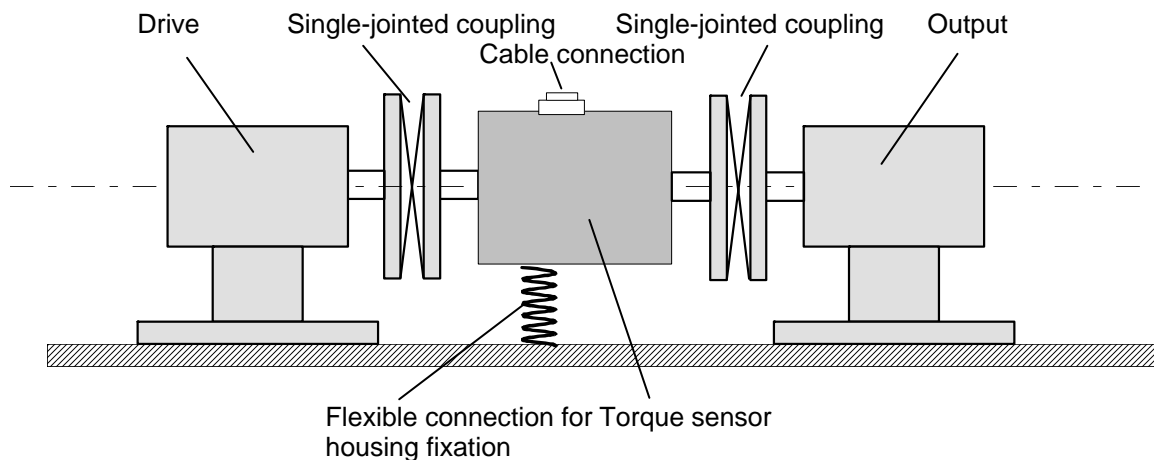

In this case, with both single-jointed couplings, the torque sensor forms a double-jointed coupling. A single-jointed coupling can only balance axial and angular misalignments.



In this installation case, double-jointed couplings can not be used for both sides!  
**Risk of Breakage!**



#### 4.4 Foot Version Assembly

The housing of the sensor is designed as a bearing block. A full coupling must be installed at both shaft ends. By this, inevitable misalignments can be balanced, which can occur during the period of operation.

If no couplings are used, very large transverse forces can affect the sensor. In addition, large forces occur on the bearings in drive and output, which limit their life span very strongly.

Furthermore large bending moments occur in the shaft. At small torques ( $< 20 \text{ Nm}$ ) connect the sensor electrically during the assembly and observe the signal, the measurement signal may not exceed the limit values

Shafts have to be cleaned with solvent (e.g. acetone) before the assembly

No foreign bodies may adhere to them.

Shift couplings on shaft (use entire clamping length of the coupling) and align shafts.

Absolutely note that the data of the couplings (axis offset, angular offset, tension, compression) are not exceeded.

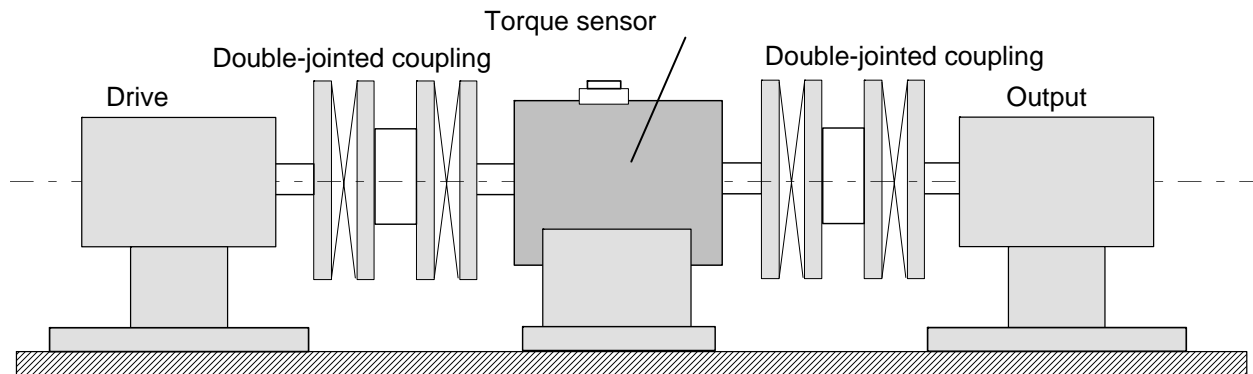
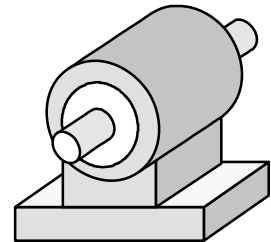

**Caution:** During the assembly inadmissibly large forces may not act on the sensor or the couplings.

## 5 Electrical Connection

### 5.1 Pin Connection

Also see test certificate.

8-pin	Analog	
1	Excitation +	12 ... 28 VDC
2	Excitation GND	0 V
3	Signal	$\pm 5 \text{ V} / (\pm 10 \text{ V})$
4	Signal GND	0 V
5	Calibration control	L < 2,0 V; H > 3,5 V
6	Option angle A	TTL
7	Option angle B	TTL
8	NC	

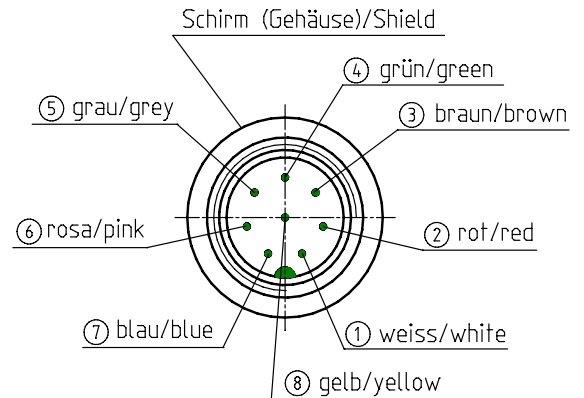

View: socket on soldering side

12-pin	Analog		Digital	
A	NC		NC	
B	Option angle B	TTL	Option angle B	TTL
C	Signal	$\pm 5 \text{ V} / (\pm 10 \text{ V})$	NC	
D	Signal GND	0 V	NC	
E	Excitation GND	0 V	Excitation GND	0 V
F	Excitation +	12 ... 28 VDC	Excitation +	12 ... 28 VDC
G	Option angle A	TTL	Option angle A	TTL
H	NC		NC	
J	NC		Output B	RS485
K	Calibration control	L < 2,0 V; H > 3,5 V	NC	
L	NC		Output A	RS485
M	Housing		Housing	

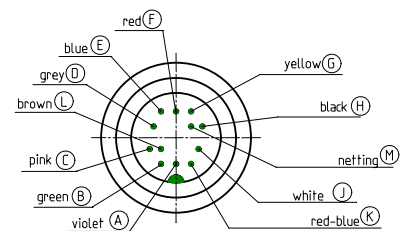

View: socket on soldering side

### 5.2 Calibration Control

Only use calibration control in unloaded condition of the torque sensor.

#### 5.2.1 Calibration Control at Analog Output

By applying voltage of +5 V to +28 V the calibration control will switch on.

Voltage below 2,8 V will switch off the calibration control.

12-pin	
E	Excitation GND
K	Calibration control

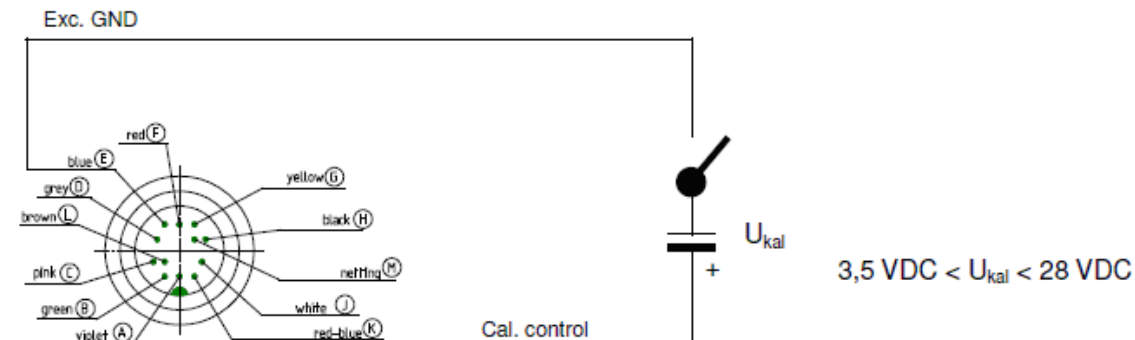

### 5.2.2 Calibration Control at RS485

The calibration control switch on is carried out by a command.  
For this, see command SCMD\_WriteFullStroke from burster Protocol (document no. 090110).

### 5.3 Cable

Only use a shielded cable with preferably small capacity. We recommend measuring cables from our product range. They have been tested in combination with our sensors and meet the metrological requirements.

### 5.4 Shielding Connection

In combination with the sensor and the external electronics, the shield forms a Faraday Cage. By this, electromagnetic disturbances do not have any influence on the measurement signal.

### 5.5 Running of Measuring Cables

Do not run measuring cables together with control or heavy-current cables. Always assure that a large distance is kept to engines, transformers and contactors, because their stray fields can lead to interferences of the measuring signals.

If troubles occur through the measuring cable, we recommend to run the cable in a grounded steel conduit.

### 5.6 Angle (Option)

At angle or speed measurement, the pulses / revolutions are acquired. By a second transmitter trace, displaced by 90° and flank evaluation, the pulses / revolutions can be quadrupled. The trace, displaced by 90°, can also be used for the rotational direction detection.

See corresponding data sheet for the output levels.

Supply for angle sensor

Stabilized supply voltage	5 V ±25 mV
Current consumption max.	20 mA

Impulse Evaluation with a second 90°-shifted Impulse Track

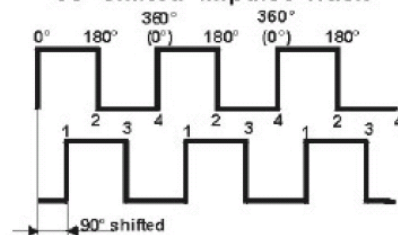

## 6 Measuring

### 6.1 Engaging

The warming-up period of the torque sensor is approx. 5 min. Afterwards the measurement can be started.



The warming-up period of the torque sensor is approx. 5 min.

### 6.2 Direction of Torque

Torque means clockwise or counter-clockwise torque if the torque acts clockwise when facing the shaft end. In this case a positive electrical signal is obtained at the output.

Torque sensors by burster can measure both, clockwise and counter-clockwise direction.

### 6.3 Static / Quasi-Static Torques

Static and/or quasi-static torque is a slowly changing torque.

The calibration of the sensors occurs statically on a calibration device.

The applied torque may accept any value up to the nominal torque.

## 6.4 Dynamic Torques

### 6.4.1 General

The static calibration procedure of torque sensors is also valid for dynamic applications.

Note: The frequency of torques must be smaller than the natural frequency of the mechanical measurement setup.

The band width of alternating torque must be limited to 70 % of the nominal torque.

### 6.4.2 Natural Resonances

Estimate of the mechanical natural frequencies:

$$f_0 = \frac{1}{2 \cdot \pi} \cdot \sqrt{c \cdot \left( \frac{1}{J_1} + \frac{1}{J_2} \right)}$$

$f_0$  = Natural Frequency in Hz  
 $J_1, J_2$  = Moment of Inertia in kg\*m<sup>2</sup>  
 $c$  = Torsional Rigidity in Nm/rad

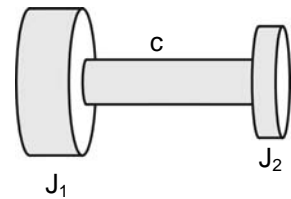

Further methods for the calculation of natural resonances are corresponding purchasable programs or books (e.g. Holzer-Procedure, Dubbel, Taschenbuch für den Maschinenbau, Springer Verlag)



An operation of the device in natural resonance can lead to permanent damages.

## 6.5 Speed Limits

The maximum speed indicated in the data sheet may not be exceeded in any operating state..

## 6.6 Disturbance Variables

By disturbances, measured value falsifications can occur by

- Vibrations,
- Temperature gradients,
- Temperature changes,
- Arising disturbance variables during operation, e.g. imbalance,
- Electrical disturbances,
- Magnetic disturbances,
- EMC (electromagnetic disturbances),

Therefore avoid these disturbance variables by decoupling of vibrations, covers, etc.

## 7 Maintenance

### 7.1 Maintenance Schedule

Action	Frequency	Date	Date	Date
Control of cables and connectors	1x p.a.			
Calibration	< 26 months			
Control of fixation (flanges, shafts)	1x p.a.			
Have bearings exchanged by burster	20000 hrs operating time			

## 7.2 Trouble Shooting

This chart should help to search for the most frequent errors and their elimination

Problem	Possible Cause	Trouble Shooting
No signal	No sensor excitation	<ul style="list-style-type: none"> <li>• Outside of permissible range</li> <li>• Connect excitation</li> <li>• Cable defect</li> <li>• No mains supply</li> </ul>
	Signal output connected wrong	<ul style="list-style-type: none"> <li>• Connect output correctly</li> <li>• Evaluation electronics defect</li> </ul>
Sensor does not react to torque	Shaft not clamped	<ul style="list-style-type: none"> <li>• Clamp correctly</li> </ul>
	No power supply	<ul style="list-style-type: none"> <li>• Outside of permissible range</li> <li>• Connect supply</li> <li>• Cable defect</li> <li>• No mains supply</li> </ul>
	Cable defect	<ul style="list-style-type: none"> <li>• Repair cable</li> </ul>
	Connector connected wrong	<ul style="list-style-type: none"> <li>• Connect correctly</li> </ul>
Signal has dropouts	Axial position rotor to stator outside of tolerance	<ul style="list-style-type: none"> <li>• Align rotor</li> </ul>
	Cable defect	<ul style="list-style-type: none"> <li>• Repair cable</li> </ul>
Zero point outside of tolerance	Cable defect	<ul style="list-style-type: none"> <li>• Repair cable</li> </ul>
	Shaft mounted distorted	<ul style="list-style-type: none"> <li>• Mount correctly</li> </ul>
	Distorted shaft string	<ul style="list-style-type: none"> <li>• Release from distortion</li> </ul>
	Strong lateral forces	<ul style="list-style-type: none"> <li>• Reduce lateral forces</li> </ul>
	Distorted flanges	<ul style="list-style-type: none"> <li>• Check evenness of flange-surfaces</li> </ul>
	Shaft overloaded	<ul style="list-style-type: none"> <li>• Send to manufacturer</li> </ul>
Wrong torque indication	Calibration not correct	<ul style="list-style-type: none"> <li>• Re-calibrate</li> </ul>
	Sensor defect	<ul style="list-style-type: none"> <li>• Repair by manufacturer</li> </ul>
	Torque shunt	<ul style="list-style-type: none"> <li>• Eliminate shunt</li> </ul>
Oscillations	Alignment of shaft not correct	<ul style="list-style-type: none"> <li>• Align correctly</li> </ul>
	Unbalance	<ul style="list-style-type: none"> <li>• Balance the corresponding parts</li> </ul>

## 8 Decommission

All sensors must be dismantled professionally. Do not strike sensor housings with tools. Do not apply bending moments on the sensor, e.g. through levers. The torque sensor must be supported to avoid falling down during the dismantling.

## 9 Transportation and Storage

The transportation of the sensors must occur in suitable packing.

For smaller sensors, stable cartons which are well padded are sufficient (e.g., air cushion film, epoxy crisps, paper shavings). The sensor should be tidily packed into film so that no packing material can reach into the sensor (ball bearings).

Larger sensors should be packed in cases.

### 9.1 Transportation

Only release well packed sensors for transportation. The sensor should not be able to move back and forth in the packing. The sensors must be protected from moisture.

Only use suitable means of transportation.

## 9.2 Storage

The storage of the sensors must occur in dry, dust-free rooms, only.  
Slightly lubricate shafts and flanges with oil before storing (rust).

## 10 Disposal

The torque sensors must be disposed according to the valid provisions of law.  
For this, see our "General Terms and Conditions" [www.burster.it](http://www.burster.it)

## 11 Calibration

At the time of delivery, torque sensors have been adjusted and tested with traceable calibrated measuring equipment at factory side. Optionally, a calibration of the sensors can be carried out.

### 11.1 Proprietary Calibration

Acquisition of measurement points and issuance of a calibration protocol. Traceable calibrated measuring equipment is being used for the calibration. The sensor data are being checked during this calibration.

### 11.2 DKD-Calibration

The calibration of the sensor is carried out according to the guidelines of the DKD. The surveillance of the calibrating-laboratory takes place by the DKD. At this calibration, the uncertainty of measurement of the torque measuring instrument is determined. Further information can be obtained from burster.

### 11.3 Re-Calibration

The recalibration of the torque sensor should be carried out after 26 months at the latest.  
Shorter intervals are appropriate:

- Overload of the sensor
- After repair
- After inappropriate handling
- Demand of high-quality standards
- Special traceability requirements

## 12 Data Sheet

See [www.burster.it](http://www.burster.it)